

# Raystar 125 GPS Receiver Owner's Handbook

**Raymarine**  
www.raymarine.com

## Welcome to the Raystar RS125 GPS Receiver



Your handbook contains an explanation of how to install, operate and maintain your Raystar RS125 GPS Receiver.

### Intended Use

This product is a GPS antenna with a built-in position fixing receiver using either NMEA0183 (Version 2.3 or later), or Raymarine SeaTalk data output. The intended application is for leisure marine boats and workboats not covered by IMO/SOLAS carriage requirements.

## What's in the box?....

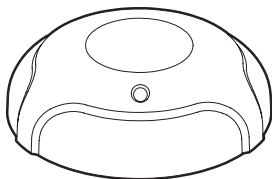

Part No: R38103  
Raystar RS125 GPS Receiver

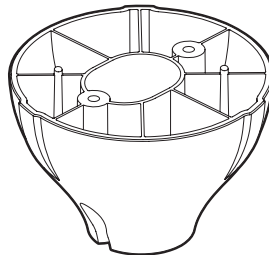

Part No: E35018  
Pole mount kit

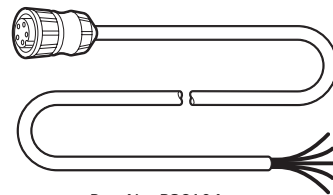

Part No: R38104  
10m (33ft) NMEA/SeaTalk  
connection cable

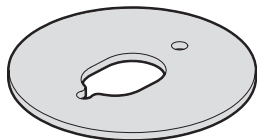

Flush mount gasket

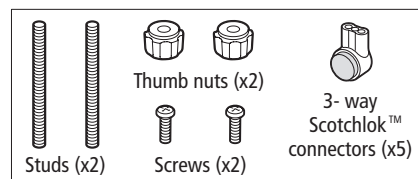

Studs (x2)

Thumb nuts (x2)

Screws (x2)

3- way  
Scotchlok™  
connectors (x5)

The Raystar RS125 GPS Receiver has no user serviceable parts.

## What tools do I need to install it?....

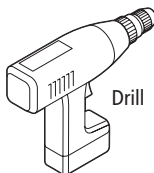

Drill



6mm (1/4 in)  
Drill bit



20mm (13/16 in)  
Drill bit

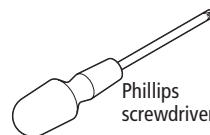

Phillips  
screwdriver

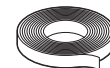

Adhesive tape

## Safety notices

### **WARNING: Navigation aid**

Although this product has been designed to be accurate and reliable, many factors can affect its performance. As a result, it should only be used as an aid to navigation and should never replace common sense and navigational judgement. Always maintain a permanent watch so you can respond to situations as they develop.

### **WARNING: Product installation**

This equipment must be installed and operated in accordance with the instructions contained in this handbook. Failure to do so could result in poor product performance, personal injury and/or damage to your boat.

### **WARNING: Electrical safety**

Make sure the power supply is switched off before you make any electrical connections.

### **WARNING: Lithium battery**

This unit has a lithium battery fitted. DO NOT attempt to recharge this battery. DO NOT incinerate this battery. Ensure you follow local regulations when disposing of this unit.

## Where can I install the unit?....

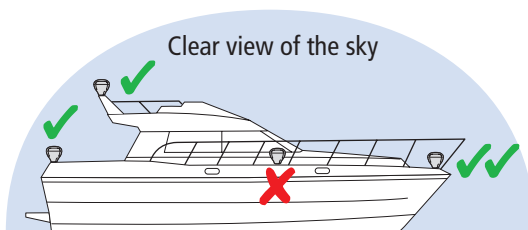
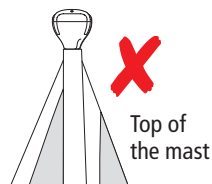
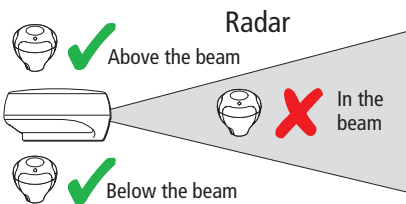
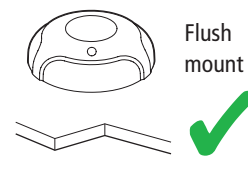
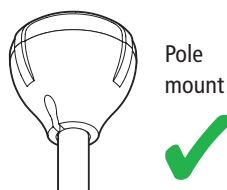

### VHF Radio and other antenna

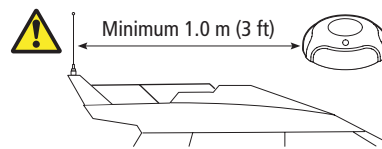

### To mount the unit on a pole....

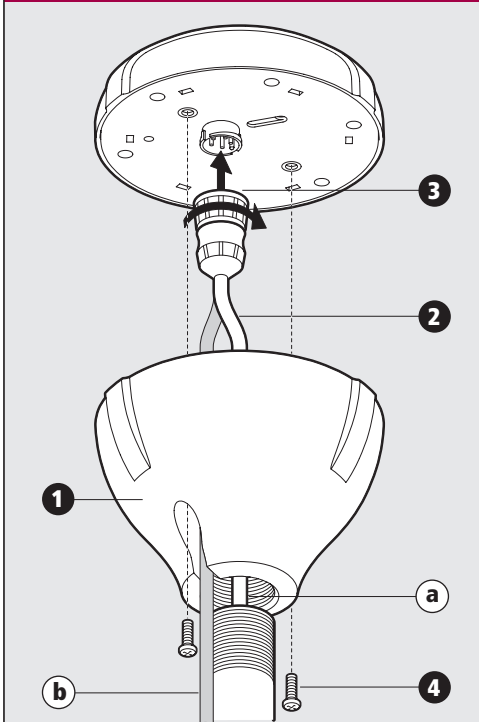

- 1 Securely attach the pole mount base to a suitable pole.
- 2 Pass the cable and connector through either
  - a the center of the pole mount bracket and the pole, or
  - b the cable exit hole alongside the center hole.
- 3 Attach the connector securely to the plug in the base of the unit.
- 4 Secure the receiver to the pole mount base using the screws provided.

#### Notes:

1. To mount the receiver on a pole, you will need a pole of suitable length with a 1 inch 14 TPI thread not exceeding 20mm in length.

2. To rail mount the receiver you will need to purchase a suitable rail mount bracket

### To flush mount the unit....

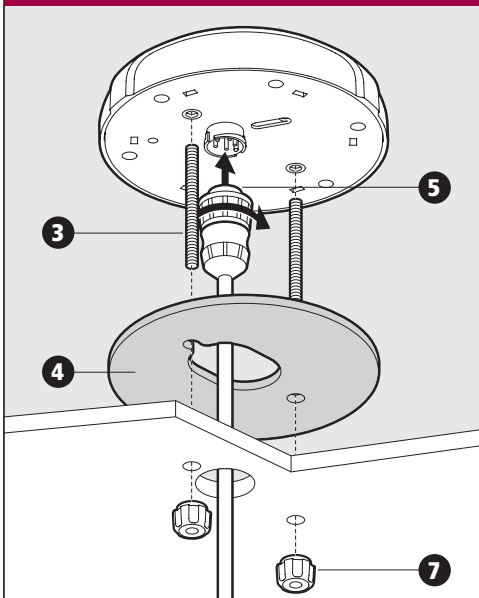

- 1 Use the template supplied in this handbook to mark the two fixing holes and the center hole.
- 2 Drill the holes using the drill sizes shown on the template.
- 3 Screw the two fixing studs into the underside of the receiver unit.
- 4 Place the waterproof gasket into position on the underside of the receiver.
- 5 Attach the connector securely to the plug in the base of the unit and pass the cable through the center hole on the mounting surface.
- 6 Carefully position the receiver so that the mounting studs pass through the holes in the mounting surface.
- 7 Secure the receiver to the mounting surface using the two thumb nuts (these should be hand-tight only).

## To connect the RS125 using Scotchlok connectors....

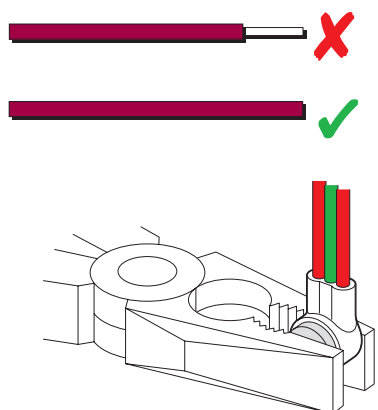

- ❶ Using suitable wire clippers, remove the tinned ends from the individual cables. Leave the insulation intact.
- ❷ Place the wires to be joined into the connectors, ensuring correct polarity and that the wires are fully pushed home.
- ❸ Using a pair of pliers, crimp the connector bulb together ensuring that a secure connection has been made.
- ❹ Ensure the cables are secured in a suitable position to prevent the joint being placed under strain.

## To connect to NMEA 0183....

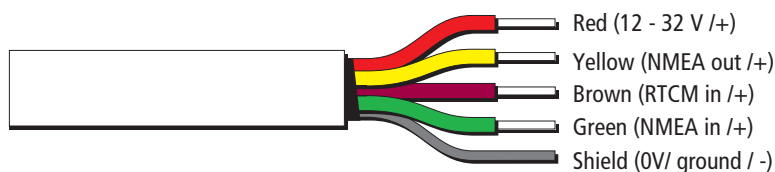

### NMEA sentences

Output sentences:

GPGGA, GPGSA, GPGSV, GPGLL, GPRMC, GPDTM, GPGNS, GPVTG, PRAYA

Input sentences:

PRAYI, PRAYE, PRAYA

**Note:** If the Brown (RTCM) and Green (NMEA in/+) wires are not used, they must be suitably grounded.

If you do not have a breaker in the power circuit, an in-line 0.5 A quick blow fuse should be fitted to the positive (red) lead of the cable.

## To connect to SeaTalk....

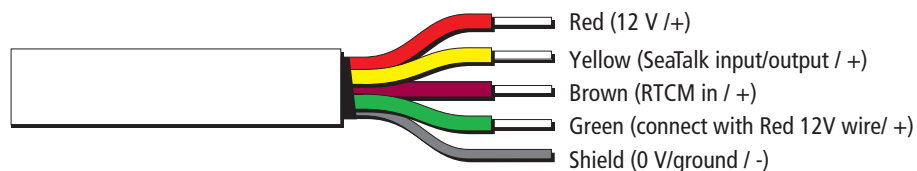

**Note:** If the Brown (RTCM) wire is not used, it must be suitably grounded to 0 Volts.

If you do not have a breaker in the power circuit, an in-line 0.5 A quick blow fuse should be fitted to the positive (red) lead of the cable.

## To connect to a C-Series or E-Series display using SeaTalk....

### C-Series

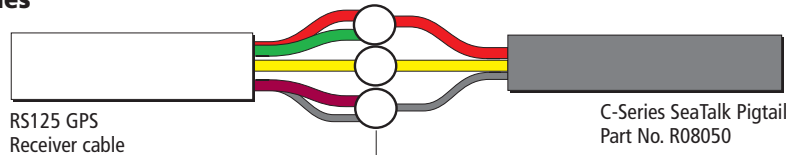

### E-Series

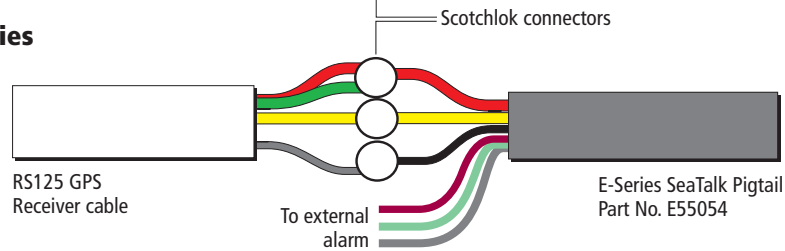

In SeaTalk network installations containing other power devices in addition to your Raystar 125 GPS receiver (e.g. ST series instruments, autopilot controllers, etc.) you should not fix the red wire on your C-Series SeaTalk pigtail to the GPS receiver or overall SeaTalk network.

If you are not using a land-based DGPS antenna on your Raystar 125 GPS receiver (most installations do not), you should connect the brown RTCM input to the shield wire (ground). This will prevent outside RF energy from inadvertently injecting noise into the system.

## To connect to a Personal Computer using NMEA

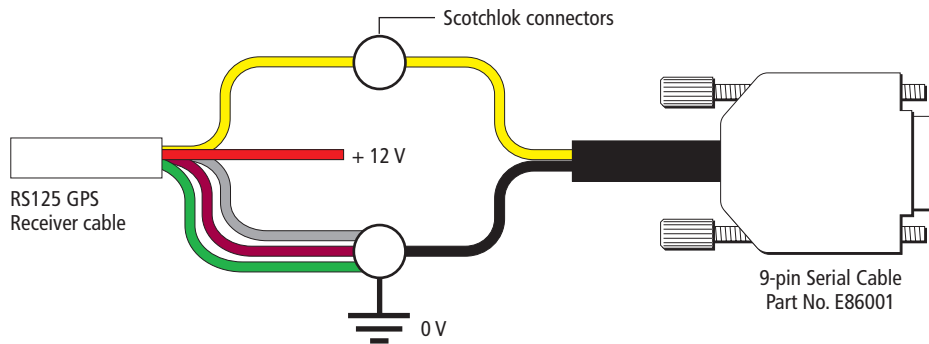

If you are connecting your RS 125 GPS receiver to a PC, you will need a Serial Data Cable, Part No. E86001. Connect the Yellow from the RS 125 to the Yellow of the Serial Data Cable. Connect the Red from the RS 125 to the positive of your boat's 12 V DC power supply. Connect the Brown, Green and Shield from the RS 125 and a Black from the Serial Data Cable to your boat's ground.

## What do the lights mean?....

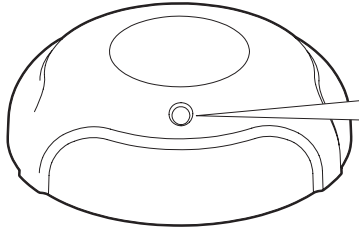

- Flashing RED**  
Unit is in bootcode, either being upgraded or unable to boot.
- Flashing ORANGE**  
Unit is running, but does not have a fix.
- Flashing GREEN**  
Unit is running and has a fix.  
1 flash every 2 seconds indicates NMEA connection.  
1 flash every 4 seconds indicates SeaTalk connection.

## SOG/COG filter....

The integral SOG/COG filter fitted to your RS125 compensates for the oscillating motion of your boat to give a clearer indication of the boat's course and speed.

Slow moving boats, or boats sailing in rough seas will benefit from a high filter setting, whereas a powerboat that can quickly change speed and direction will benefit from a low setting.

The default setting for your RS125 is MEDIUM.

Adjustment of the SOG/COG filter is made from your system display.

For full details of how to adjust the SOG/COG filter refer to the relevant Manufacturer's manual.

## Accessories....

You can obtain the following accessories to help you quickly and easily connect your RS125 to existing equipment:

### E36013 - 600mm Antenna conversion cable

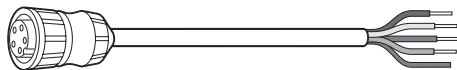

The antenna conversion cable enables you to connect your RS125 receiver to an existing RS120, RS112 or RS114 cable, saving the time and trouble of running a new cable.

### E36014 - 1000mm Display conversion cable

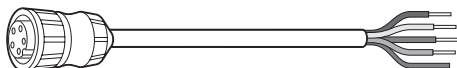

The display conversion cable enables you to quickly connect your RS125 receiver to an existing RC425 or RC420 display, saving time and trouble.

## Important Information

### EMC conformance

All Raymarine equipment and accessories are designed to the best industry standards for use in the recreational marine environment. The design and manufacture of Raymarine equipment and accessories conforms to the appropriate Electromagnetic Compatibility (EMC) standards, but correct installation is required to ensure that performance is not compromised. For full details and installation guidelines refer to our web site at [www.raymarine.com](http://www.raymarine.com)

### Declaration of conformity

We, Raymarine Limited, Quay Point, Portsmouth, Hampshire, England PO6 3TD declare, under our sole responsibility, that the product identified in this declaration, and to which this declaration relates, is in conformity with the essential requirements of European Parliament and Council Directive 1999/5/EC on radio equipment and on telecommunication terminal equipment and the mutual recognition of their conformity.

Product name: Raystar 125 GPS Receiver

Product number: E32042

This product has been assessed to Conformity Procedure Annex IV of the Directive. The assessment is consistent with a Technical Construction File showing conformity with the essential requirements of the Directive and has been reviewed by Notified Body No.0191.

Signed:  A. Abbas, International Compliance Manager. Raymarine Ltd.  
21st January 2005

### CE conformity

This product is labeled with the CE conformity mark: **CE 0191**

### SiRF Technology Inc.

This product uses certain elements of software supplied to Raymarine by SiRF Technologies Inc.

For full details of their licensing agreement refer to our website at [www.raymarine.com](http://www.raymarine.com)

### Warranty

To register your new Raymarine product, please take a few minutes to fill out the warranty card.

It is important that you complete the owner information and return the card to us to receive full warranty benefits.

Your product can also be registered via our web site [www.raymarine.com](http://www.raymarine.com)

### Handbook information

To the best of our knowledge, the information contained in this handbook was correct as it went to press. Raymarine cannot accept any liability for any inaccuracies or omissions it may contain.

In addition, our policy of continuous product improvement may change specifications without notice. As a result, Raymarine cannot accept liability for any differences between the product and the handbook.

**To get Technical Support....**

**[www.raymarine.com](http://www.raymarine.com)**

**United States**

**Raymarine Technical Support**  
1-800-539-5539 extension 2444, or  
(603) -881-5200

**Product Repair and Service**  
Raymarine Product Repair Center  
21 Manchester Street,  
Merrimack, NH 03054 - 4801  
1-800-539-5539

Opening hours:  
Monday through Friday 0815 - 1700  
Eastern Standard or Eastern Daylight  
Savings Time.

**Europe**

**Technical Support  
Services  
Accessories**

Raymarine UK Limited  
Anchorage Park  
Portsmouth  
PO3 5TD  
England

Tel:  
+44(0)23 9271 4713  
Fax:  
+44(0)23 9266 1228

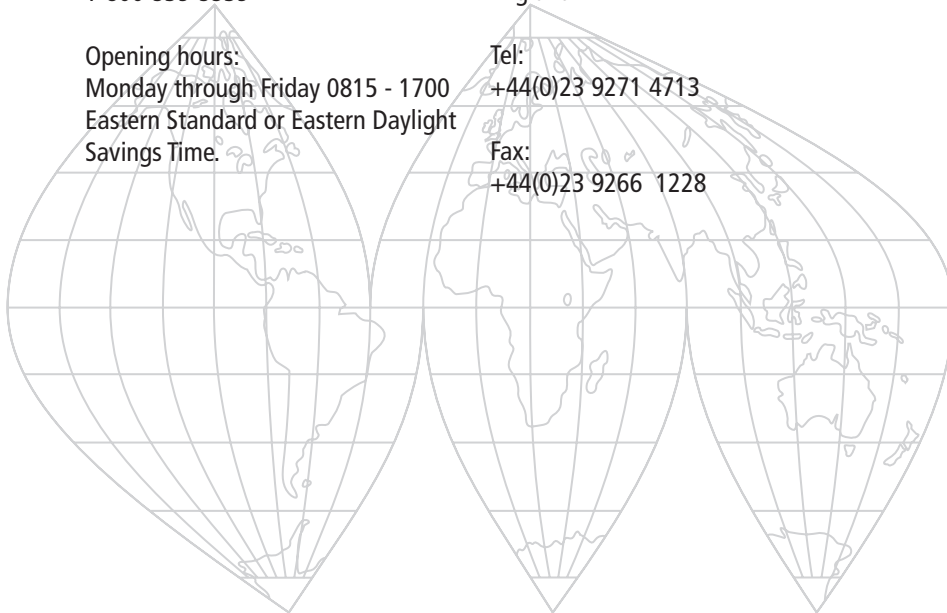

**Help us to help you**

When requesting service, please quote the following product information:  
Equipment type ● Model number ● Serial number

**Raymarine UK Limited**  
Quay Point, Northarbour Road,  
Portsmouth, Hampshire  
England PO6 3TD  
Tel: + 44 (0)23 9269 3611  
Fax: + 44 (0)23 9269 4642  
**[www.raymarine.com](http://www.raymarine.com)**

**Raymarine Incorporated**  
21 Manchester Street,  
Merrimack, NH 03054 - 4801  
USA  
Tel: 603-881-5200  
Fax: 603-864-4756  
**[www.raymarine.com](http://www.raymarine.com)**

**Raymarine**

Document No: 81247\_3  
Date: April 2005

© Raymarine 2005